

1/35 MILITARY MINIATURE VEHICLE UPGRADE SERIES PE351021

# Modern Poland PL-01 Prototype Basic

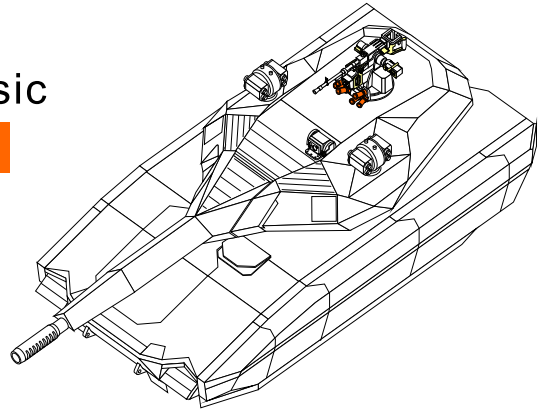





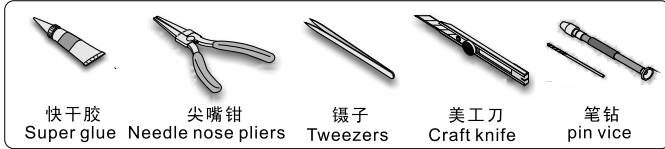

## 现代波兰PL-01隐身坦克改造件

[For TAKOM 2127]



■ 推荐使用工具 RECOMMENDED TOOLS



-   
 安装  
install
-   
 折叠  
bend
- A1**  
 改造件零件编号  
PE/resin part number
- B12**  
 原零件编号  
kit part number
- C22**  
 被替换的原零件编号  
replaced kit part number
-   
 另一侧相同制作  
repeat on opposite side
-   
 切除  
remove
-   
 打磨  
grind off
-   
 弧度卷曲  
radial bending
- x2**  
 制作若干组  
multiple assembly
-   
 选择安装  
alternative
-   
 钻孔  
drill
-   
 用胶棒制作  
make from plastic rod

  
 用尖端在凹槽处冲压  
use penpoint to press on the dent

蚀刻片零件内侧面向上  
Put the part upside down  
用笔尖在凹槽处刻  
Use penpoint to press on the dent

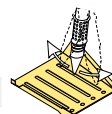

<http://www.voyagermodel.com/productdetails.asp?itemid=PE351021>



**VOYAGER MODEL**

更多PE351021样品照片参考请扫一扫  
 MORE PICTUER OF PE 351021  
 REFERENCE SCAN HERE

**金属件**  
Metal part **x6**

**自制**  
Scratch build